

Oxygen Saturation Monitor

PULSOX™-2

INSTRUCTION MANUAL



MINOLTA

Safety Symbols

Warnings and precautions noted in this manual are indicated by the following markings, designed to prevent accidents caused by erroneous handling of the equipment.



This indicates text consisting of a warning or precaution relating to safety. Please read the text carefully and use the equipment safely.



This indicates an action which is prohibited. The prohibited action should never be carried out, under any circumstances.



This indicates instructions concerning an action. Always follow the instructions carefully.



This indicates an action which is prohibited. Never disassemble the product or unit.



This symbol indicates type BF applied part. The instrument provide a particular degree of protection against electric shock, particularly the leakage current and reliability of the protective earth connection with an F-TYPE APPLIED PART. F-TYPE APPLIED PART indicates applied part isolated from all other parts of the instrument to such a degree that the patient leakage current allowable in single fault condition is not exceeded when a voltage equal to 1.1 times the highest rated mains voltage is applied between the applied part and earth.

IPX4 This symbol indicates Splash-proof equipment.

Authorized Standards For North America

UL, C_ UL:



WITH RESPECT TO ELECTRIC SHOCK, FIRE AND MECHANICAL HAZARDS ONLY IN ACCORDANCE WITH UL 2601-1, CAN/CSA C22.2 No.601.1

MEDICAL EQUIPMENT (70SA)

For Europe

CE (Medical Device Directive):



This instrument complies with EN60601-1, EN60601-1-2, EN1441, EN46001.

SAFETY PRECAUTIONS

To ensure correct use of this instrument, read the following points carefully and adhere to them. After you have read this manual, keep it in a safe place where it can be referred to anytime a question arises.



WARNING

(Failure to adhere to the following points may result in death or serious injury.)



Do not use the instrument in places where flammable or combustible gases (anesthetic gas etc.) are present. Doing so may cause a fire.



Do not put the batteries on a fire, short-circuit them, heat them or disassemble them. Doing so may cause explosion or heat generation, resulting in fire or injury.



This device is designed to measure the oxygen saturation level (SpO₂) and the pulse rate. It should not be used as a warning device to detect cessation of breathing or irregular breathing during sleep.



CAUTION

(Failure to adhere to the following points may result in injury or damage to the instrument or other property.)



Do not use batteries other than those specified by MINOLTA. When installing batteries in the instrument, make sure that they are correctly oriented according to the (+) and (-) marks. For a model which use more than one battery, do not mix new and old batteries, or mix batteries of different types. Failure to adhere to these instructions may cause explosion of the batteries or leakage of electrolyte, resulting in fire, injury or corrosion.



Do not place the instrument on an unstable or sloping surface. Doing so may result in its dropping or overturning, causing injury. Take care not to drop the instrument when carrying it.



Do not operate the instrument for long periods of time with a finger holder attached to a patient. Low-temperature burn, redness or rash may result. If you feel pain or itchiness, stop use of the instrument immediately and consult a doctor. A doctor should also be consulted before using the instrument on infants, those with peripheral blood circulation problems or those with sensitive skins.



If alkali fluid from the battery comes in contact with eyes, skin, or clothing, immediately wash the affected area and see a physician for treatment.





Do not use wet batteries. do not use instrument if the battery compartment contains water. Doing so may cause explosion or heat generation, resulting in fire or injury.



Do not disassemble or modify the instrument. Doing so may cause a fire or electric shock

1. BEFORE OPERATION

Safety Notes

-  CAUTION: Federal law restricts this device to sale by or on the order of a physician.
-  The PULSOX-2 is a medical instrument, so instructions given by a doctor must be adhered to.
-  The instrument is designed for measurement of the oxygen saturation (SpO₂) of arterial blood and the pulse rate. Do not use it for any other purposes, such as warning of sleep apnea and breathing abnormalities.

Package Contents

Make sure that all the following items are supplied with the instrument.

- 1 PULSOX-2 main unit (×1)
- 2 Neck strap NS-M (×1)
- 3 AAA-size alkaline battery (×2)

Main Features

This pulse type oximeter emits light to the user's finger to measure the oxygen saturation (SpO₂ %) of arterial blood and the pulse rate.

- Compact, lightweight and portable
The light weight, compactness, and portability of the PULSOX-2 allows it to be used for inspection of both outpatients and inpatients. In addition, it is easily transported by both doctors and nurses for house calls or home-care patients.
- Battery-operated
The PULSOX-2 is operated by two AAA-size alkaline batteries.

2. NAMES OF PARTS

■ Main unit

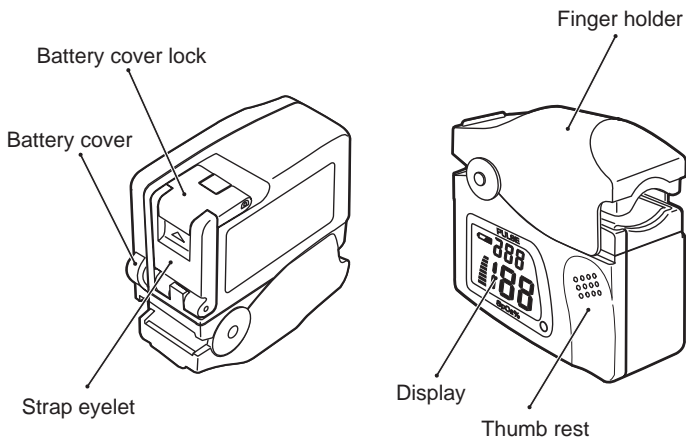

Battery cover: Open or close this cover when replacing the batteries with new ones.

Battery cover lock: It is used to lock the battery cover.

Strap eyelet: Attach the neck strap to this hook.

Finger holder: Holds finger when inserted for measurement. A light source is located in the upper side, and a sensor in the lower side.

Thumb rest: Put the thumb here when you hold this instrument.

Display: Displays measured value, pulse level meter and error messages.

3. NOTES ON USE

- This instrument should be used in areas with an ambient temperature of 0 to 40°C (32 to 104°F) and a relative humidity of 30 to 95%, with no condensation.
- This is a precision instrument. To avoid the possibility of it being damaged, the instrument should not be dropped nor should heavy objects be placed on top of it.
- This instrument conforms to water-seal rating of IPX4 (IEC 60529), which ensures that the instrument will show no adverse damage even if exposed to water splashing from any direction. However, the instrument is not waterproof, so it should never be washed with water or left immersed in water.
- When the water remains in finger holder, the measurement value is not accurate. Turn the part of strap eyelet to the bottom, and remove the water.
- This instrument should not be used in areas subject to strong vibrations, nor should it be subjected to physical shock. Doing so may cause breakdown.
- The finger holder is a delicate device and should not be handled roughly nor should objects be placed on top of it.
- The accuracy of this instrument, like that of all other dual-wavelength oximeters, can be influenced by the presence of abnormal hemoglobins such as carboxyhemoglobin (HbCO) and methemoglobin. Tables 1 and 2 below show the errors which may occur due to these hemoglobins. The instrument may also be affected by cardiogreen or intravascular dyes.

Difference from the SaO₂ value to displayed value

<Table 1>

SaO ₂	HbCO		
	1%	5%	10%
50	-0.1	-0.7	-1.5
70	-0.1	-0.7	-1.5
90	-0.2	-0.8	-1.6
100	-0.2	-0.8	-1.7

Measured value is always lower than the actual value.

<Table 2>

SaO ₂	Methemoglobin		
	1%	5%	10%
50	+0.2	+1.3	+3.2
70	-0.6	-2.3	-3.2
90	-1.5	-6.0	-9.6
100	-1.8	-7.5	-12.2

Displayed value is sometimes higher than the actual value if SaO₂ is around 50%.

- Do not use a mobile telephone when using this instrument. Doing so may result in measurement error.
- This instrument may interfere with magnetic resonance imaging (MRI) procedure.
- The disposal method of AAA batteries varies according to local government regulation.
- Dispose of the battery according to the instructions given by local government regulations or ask a specialized waste service company to dispose of it.

This equipment has been tested and found to comply with the limits for medical devices to the IEC 60601-1-2:2001, Medical Device Directive 93/42/EEC . These limits are designed to provide reasonable protection against harmful interference in a typical medical installation. This equipment generates, uses and can radiate radio frequency energy and, if not installed and used in accordance with the instructions, may cause harmful interference to other devices in the vicinity. However, there is no guarantee that interference will not occur in a particular installation. If this equipment does cause harmful interference to other devices, which can be determined by turning the equipment off and on, the user is encouraged to try to correct the interference by one or more of the following measures:

- Reorient or relocate the receiving device.
- Increase the separation between the equipment.
- Connect the equipment into an outlet on a circuit different from that to which the other device's are connected.
- Consult the manufacture or field service technician for help.

4. OPERATING METHOD

Preparations

(1) Installing Batteries

(Two AAA-size batteries are required.)

1. Push the battery cover, and unlock the battery cover lock.

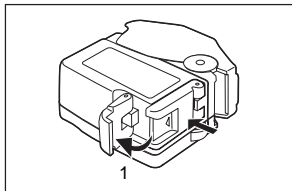

2. Open the battery cover.
3. Insert two AAA-size batteries into the battery chamber.

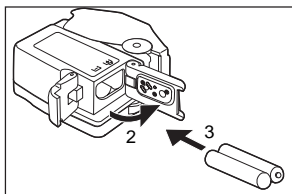

4. Close the battery cover and hold it with a finger.

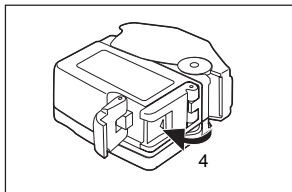

5. Close the battery cover lock until it clicks.
 - The batteries will last approximately 80 hours.
 - The battery mark will begin to blink when the battery power is low.

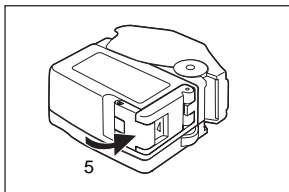

Notes on Use

- Battery replacement is the Only User Serviceable item.
- When replacing the batteries with new ones, do not mix battery types or ages.
- If the instrument will not be used for a long period of time, remove the batteries from the battery chamber. Also remove the batteries as soon as possible if they are dead.

(2) Installing the Neck Strap

By attaching the neck strap to the instrument, the instrument can be hung from the neck.

1. Pass the neck strap through the strap eyelet as shown in the figure.

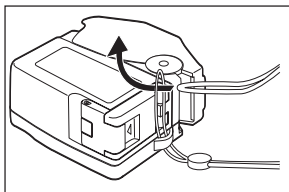

Measurements

Measurements must be taken with the index finger placed in the finger holder. This instrument must be held tightly. Put the thumb only on the thumb rest. You must not put the thumb on other positions. Don't take the pressure which is unnecessary for the forefinger. Those are important for the accurate measurement.

1. Open the finger holder.
 2. Insert the index finger and release the finger holder.
- Opening the finger holder will start measurement automatically.

The finger should be put on the position shown in the figure below.

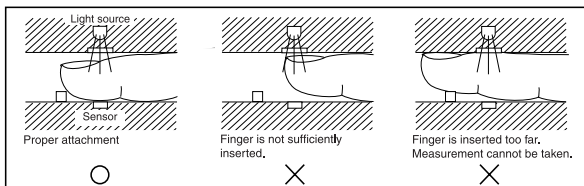
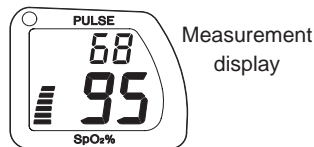
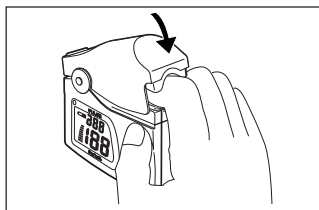
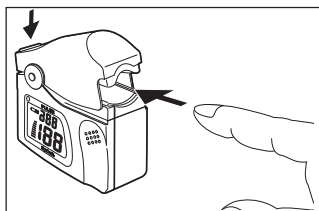

Safety Notes

- ❗ This finger holder is designed only for use on the fingers of adults, so it should not be used on any other body parts.
- ❗ Never secure the finger holder with tape or such like. Doing so may cause hemostasia or dropsy.

Notes on Use

- Remove nail polish before taking measurements.
- If no measurement values are displayed, attach the finger holder to a thinner finger to take measurements.
- It may not be possible to take measurements in case of blood circulation or blood stream problems. In this case, remove the finger holder, rub or warm the finger to improve blood circulation, then re-attach the finger holder.
- Do not use the instrument in areas where it is exposed to strong light such as direct sunlight.

Notes on Measurements

- Check that the pulse level meter changes in synchronization with the pulse rate during measurements. In the following cases, the level meter may not operate properly, hindering display of correct values.
 - Rapid body movement
 - Finger Holder is not attached to the patient properly.
 - Arm or finger is pressed, causing bad blood circulation.
- When using the instrument, take care not to expose the finger holder to strong light.

Ending Measurements

1. Open the finger holder and remove the finger.
 - Measurement will stop automatically, and the display will go off after 10 seconds.

Notes on Use

- If the instrument will not be used for a long period of time, remove the batteries from the battery chamber.

How to Read the Measurement Values

Pulse level meter: Indicates the pulse level in 8 levels (0 to 10%, full scale if 10% or higher). The pulse level is defined as follows. (For stable measurements, adjust the measuring point of the finger holder or rub or warm the measuring point to improve blood circulation, so that the pulse level meter constantly indicates level 2 or higher.)

$$\text{Pulse level (\%)} = \frac{\text{Variable transmittance}}{\text{Constant transmittance}} \times 100$$

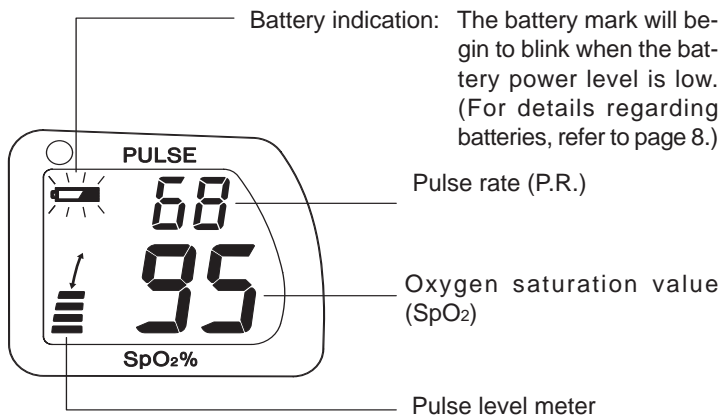

Calculation method for displayed values

Oxygen saturation value (SpO₂):

Value obtained by performing moving averaging for the last 5 seconds is updated and displayed every second.

Pulse rate (P.R.):

Value obtained by performing moving averaging for the last 8 pulse rates is updated and displayed every second.

Back Light

The backlight will light up automatically when the surroundings become dark.

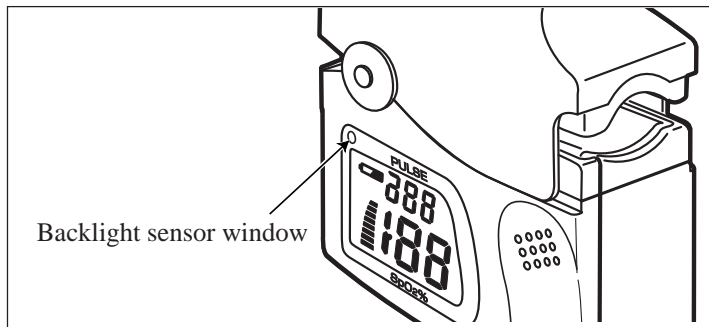

When backlight isn't turned by the bright surroundings, cover the backlight sensor window with finger.





- Once the backlight is lit, it will remain lit until measurement stops.
- When battery mark is blinking, backlight isn't turned on. Please replace the battery.

Error Messages

- Messages relating to connection of the finger holder and attachment to the patient

Error Messages	Cause	Solution
	<ul style="list-style-type: none"> • Insufficient light for measurement. • Strong light enters the finger holder's sensor directory. 	<ul style="list-style-type: none"> • Check that the finger holder is properly attached to the patient. • Clean the light-source and sensor sections. • Take measures to prevent direct entry of strong light to the finger holder.
	<ul style="list-style-type: none"> • Pulse signal required for measurement is not being received. 	<ul style="list-style-type: none"> • Check that the finger holder is properly attached to the patient. If the finger holder is properly attached but this message still appears, the circulation in the area being measured may not be good. If this occurs, warm up the measurement location.
<p>The Measurement Value and</p>  <p>flash alternately</p>	<ul style="list-style-type: none"> • The pulse is weak and the pulse signals required for the measurement are not obtained. The measurement value is displayed, however, the accuracy of the measurement values cannot be guaranteed. Thus, the measured value must be considered as guidance only. 	<ul style="list-style-type: none"> • Attach the finger holder to the body correctly. If this message is displayed when the unit is attached to the patient correctly, the measurement conditions are regarded as blood circulation or other circulatory problems. If this occurs, warm up the measurement location. • In particular, when the pulse is weak, this error tends to occur. For improved measurement accuracy, if the finger holder is exposed to strong light, wrap it with a piece of black cloth, etc. Also make sure that the patient rests calmly to avoid influence of body movement.

■ Messages relating to the condition of the main unit

Error Messages	Cause	Solution
The Measurement Value and 	<ul style="list-style-type: none">• Motion artifact	<ul style="list-style-type: none">• Attach the finger holder to the patient properly. If this message still reappears even though the finger holder is attached properly, keep the measuring point as stationary as possible.
	<ul style="list-style-type: none">• The pulse rate exceeds the upper limit (250 bpm) of the measurement range.	<ul style="list-style-type: none">• Measurement cannot be performed when the upper limit of the measurement range is exceeded.

5. TROUBLESHOOTING

■ Main Unit

Problem	Checkpoint	Solution	Reference Page
<ul style="list-style-type: none">• Display disappeared in the middle of measurements.• No display appears when the finger holder was opened and the measurement was started.	<ul style="list-style-type: none">• Is battery power exhausted?	<ul style="list-style-type: none">• Turn the POWER switch OFF and replace the two batteries (AAA-size) with new ones.	P.7
	<ul style="list-style-type: none">• Are batteries oriented correctly (+ and - marks)?	<ul style="list-style-type: none">• Make sure that the batteries are oriented correctly.	P.7

6. In Case of Malfunction

- If a malfunction occurs, contact the nearest authorized service facility. Never disassemble the unit or attempt to repair it yourself.

7. Maintenance and Storage

- This instrument should be stored at temperatures of between -10 and 60°C (14 and 140°F) at 30 to 95% relative humidity. Do not store this instrument in areas subject to high temperatures or high humidity, and do not subject this instrument to sudden temperature changes which may result in condensation. For protection, this instrument should be stored with a drying agent such as silica gel.
- When storing the instrument:
 - Do not store the instrument in an area where it will be exposed to water.
 - Do not store the instrument in an area where direct sunlight, pressure, temperature, humidity, ventilation, sunlight, dust, strong magnetic fields, and/or saline or sulphurous atmospheres may affect the instrument.
 - Do not store the instrument on an inclined surface or on a surface which may be subject to vibrations or physical shock. (Also avoid vibrations or physical shock during transportation.)
 - Do not store the instrument in areas where chemicals are stored or where gas may be emitted.
- To avoid any problems occurring the next time the instrument is used, make sure the instrument and finger holders are cleaned and stored safely.
- If the PULSOX-2 will not be used for more than two weeks, remove batteries to avoid the possibility of damage due to leakage of electrolyte.

8. Maintenance and inspections

- Before using the instrument, carefully check that the instrument is operating safely and correctly.

9. Cleaning

- When cleaning the main unit, clean it with a cloth moistened with neutral detergent or water. Never clean it by any other methods or with any kind of solvent.
- When cleaning a finger holder, clean it using a soft cloth moistened with ethyl alcohol or cationic soap, and wipe it off using a dry soft cloth or dry it naturally.

10. SPECIFICATIONS

PULSOX-2

■ Dual-wavelength pulse-type oximeter

■ Functions:

- Measuring range: SpO₂: 0 to 100%
Pulse rate: 20 to 250 bpm
- Accuracy: SpO₂ ±2% (SpO₂:70 to 100%, 1 s.d.)
Pulse rate: ±2 bpm

■ Display

Display type: Liquid crystal display
Oxygen saturation (SpO₂)
Pulse rate number
Pulse level meter
Error messages

■ Operating temperature/humidity range

0 to 40°C (32 to 104°F); 30 to 95% relative humidity with no condensation

■ Storage temperature/humidity range

-10 to 60°C (14 to 140°F); 30 to 95% relative humidity with no condensation

■ Power

2 AAA-size batteries 3V  80mW

(This instrument can use about 80 hours continuously, when the use of the AAA alkaline battery.)

■ Dimensions (W × H × D)

69 × 60 × 28 mm

■ Weight

57 g

■ Accessory

Standard Accessory: Neck strap

■ Equipment Classification

- Protection against electric shock : Internally powered
- Type of applied part : BF
- Degree of protection against harmful ingress of water : Splash-proof equipment(IPX4)
- Not suitability for use in the presence of flammable anaesthetic mixture with air or oxygen or nitrous oxide.
- Mode of operation of Equipment : Continuous while in Use (IEC60601-1)

11. REFERENCE

Measurement Principle

Oxygen Saturation Monitor PULSOX-2 is a photometric instrument that non-invasively and continuously measures the oxyhemoglobin saturation of arterial blood (SpO_2) and the pulse rate. SpO_2 is described by the equation:

$$SpO_2 = \frac{C(HbO_2)}{C(HbO_2) + C(Hb)} \times 100 (\% SpO_2)$$

where

C (Hb): Concentration of reduced hemoglobin

C (HbO₂): Concentration of oxyhemoglobin

The light-absorption characteristics of reduced hemoglobin (Hb) are very different from those of oxyhemoglobin. The PULSOX-2 measures the changes in the absorption of red and infrared lights passing through the tissue to determine the SpO_2 of the blood. Thus, this method is free from the effects of skin color, muscles, bones, and veins.

Spectral Absorption of Hb and HbO₂

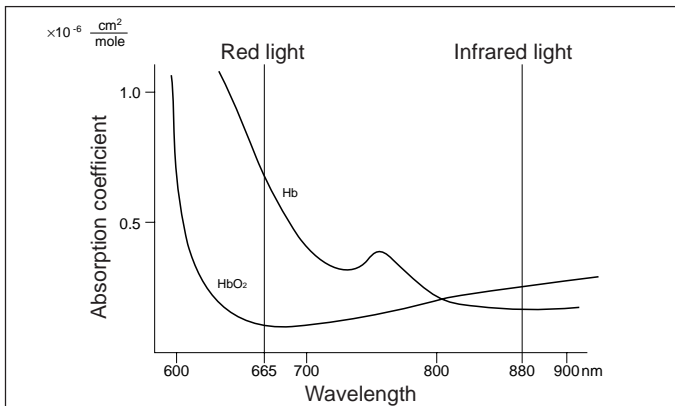

Relation between Oxygen Saturation and Partial Pressure

The relation between oxygen saturation (SpO_2 , %) and oxygen partial pressure (PaO_2 , torr or mmHg) is shown in the graph below. SpO_2 is the oxygen saturation as measured by pulse oximeters.

Oxygen Saturation vs. Oxygen Partial Pressure

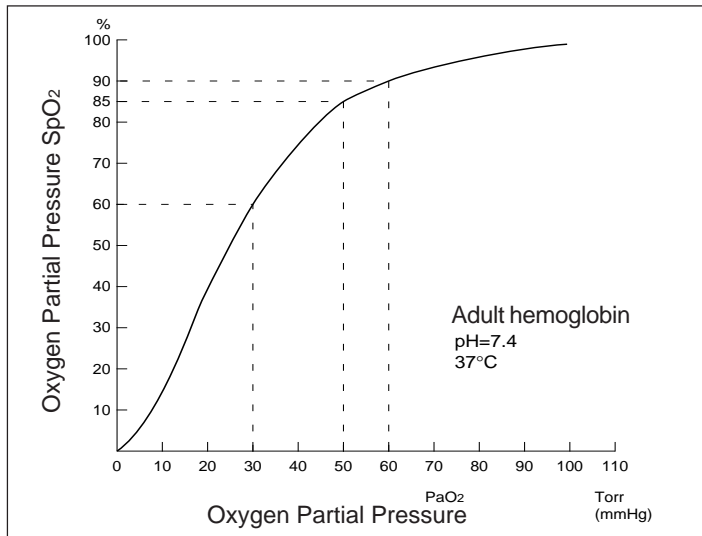

The curve of the above graph may shift to the right or left according to the pH of the blood or the body temperature. (Shift to right: acidosis, high body temperature; shift to left: alkalosis, low body temperature)

EMC Declaration

Guidance and manufacture's declaration - electromagnetic emissions		
The Model PULSOX-2 is intended for use in the electromagnetic environment specified below. The customer or the user of the Model PULSOX-2 should assure that it is used in such an environment.		
Emissions test	Compliance	Electromagnetic environment -guidance
RF emissions CISPR 11	Group 1	The Model PULSOX-2 uses RF energy only for its internal function. Therefore its RF emissions are very low and are not likely to cause any interference in nearby electromagnetic equipment.
RF emissions CISPR 11	Class B	The Model PULSOX-2 is suitable for use in all establishments, including domestic establishments.
Harmonic emissions IEC61000-3-2	Not applicable	
Voltage fluctuations/ flicker emissions IEC61000-3-3	Not applicable	

Guidance and manufacture's declaration - electromagnetic immunity			
The Model PULSOX-2 is intended for use in the electromagnetic environment specified below. The customer or the user of the Model PULSOX-2 should assure that it is used in such an environment.			
Immunity test	IEC 60601 Test level	Compliance level	Electromagnetic environment - guidance
Electromagnetic Discharge (ESD) IEC61000-4-2	6 kV contact 8 kV air	6 kV contact 8 kV air	Floors should be wood, concrete or ceramic tile, If floors are covered with synthetic material, the relative humidity should be at least 30%.
Electrical fast Transient/burst IEC61000-4-4	Not applicable		
Surge IEC61000-4-5	Not applicable		
Voltage dips, short Interruptions and Voltage variations on power supply Input lines IEC61000-4-11	Not applicable		
Power frequency (50/60Hz) magnetic field IEC61000-4-8	Not applicable		

Guidance and manufacture's declaration - electromagnetic immunity

The Model PULSOX-2 is intended for use in the electromagnetic environment specified below. The customer or the user of the Model PULSOX-2 should assure that it is used in such an environment.

Immunity test	IEC 60601 test level	Compliance level	Electromagnetic environment - guidance
Conducted RF IEC61000-4-6	Not applicable	/	/
Radiated RF IEC61000-4-3	3 V/m 80MHz to 2.5GHz	3 V/m	<p>Portable and mobile RF communications equipment should be used no closer to any part of the PULSOX-2, than the recommended separation distance calculated from the equation applicable to the frequency of the transmitter</p> <p>Recommended separation distance</p> <p>$d = 1.2\sqrt{P}$ 80MHz to 800MHz</p> <p>$d = 2.3\sqrt{P}$ 800MHz to 2.5GHz</p> <p>where P is the maximum output power rating of the transmitter in watts(W) according to the transmitter manufacturer and d is the recommended separation distance in meters (m).</p> <p>Field strength from fixed RF transmitters, as determined by an electromagnetic site survey ^a, should be less than the compliance level in each frequency range ^b.</p> <p>Interference may occur in the vicinity of equipment marked with the following symbol:</p> <div style="text-align: center;">  </div>

NOTE 1 At 80MHz and 800MHz, the higher frequency range applies.

NOTE 2 These guidelines may not apply in all situations. Electromagnetic propagation is affected by absorption and reflection from structures, objects and people.

^a Field strengths from fixed transmitters, such as base stations for radio (cellular/cordless) telephones and land mobile radios, amateur radio, AM and FM radio broadcast and TV broadcast cannot be predicted theoretically with accuracy. To assess the electromagnetic environment due to fixed RF transmitters, an electromagnetic site survey should be considered. If the measured field strength in the location in which the PULSOX-2 is used exceeds the applicable RF compliance level above, the PULSOX-2 should be observed to verify normal operation. If abnormal performance is observed, additional measures may be necessary, such as reorienting or relocating the PULSOX-2.

^b Over the frequency range 150 kHz to 80MHz, field strengths should be less than 3V/m.



MINOLTA

Minolta Co.,Ltd.

3-13, 2-Chome, Azuchi-Machi,Chuo-Ku, Osaka 541-8556, Japan

9222-1731-13

©2003 Minolta Co., Ltd.
ADDAPX(1) Printed in Japan